

FANZO SERIES



HA3051



HA3051

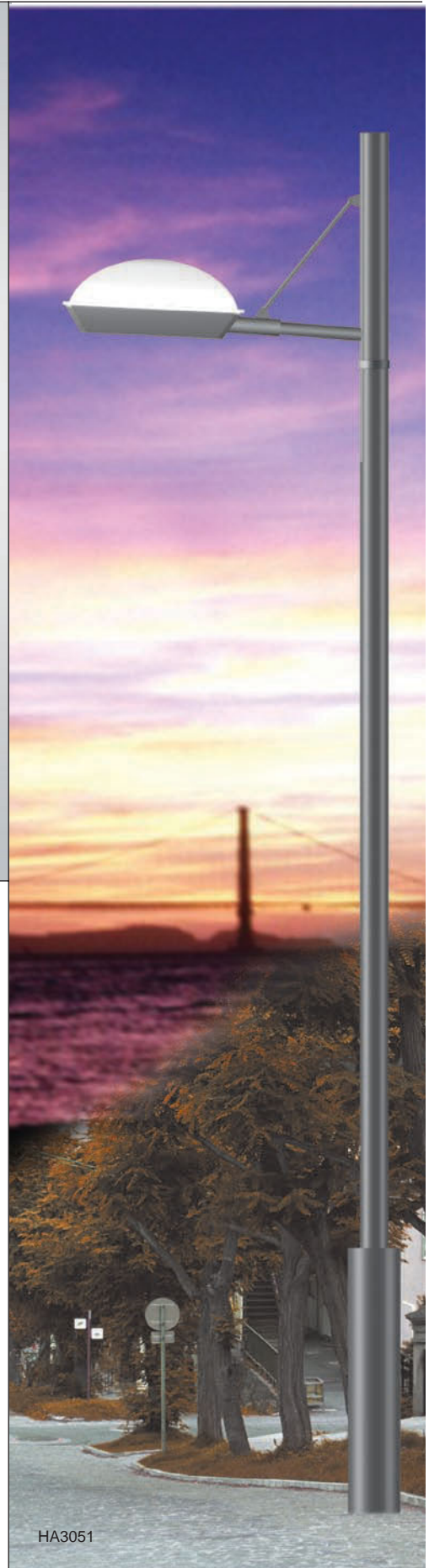

HA3051

Feature

- Contemporary style area lighting
- Very High quality for upmarket
- Heavy-duty, die-cast FRP & aluminium housing
- High efficiency toughened flat glass lens with vacuum aluminium reflector
- Tool-less removable power tray assembly for ease of maintenance
- Available with medium- or mogul-base socket



Dimensions

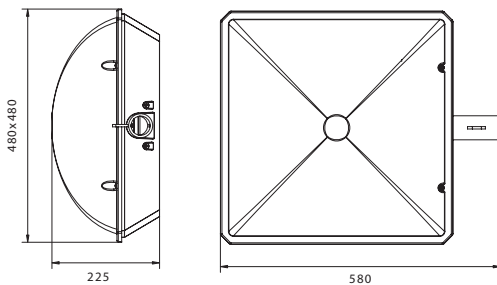

Mechanical

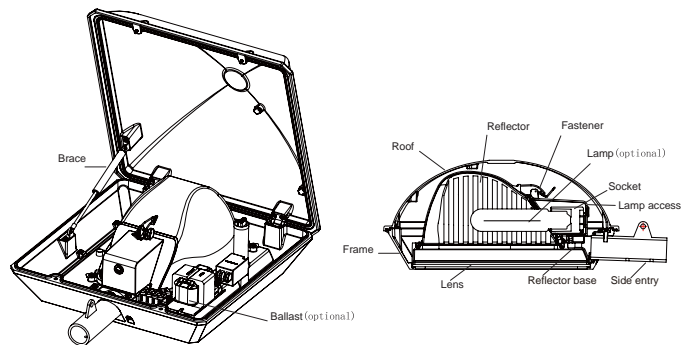

Specification

Application: Urban roads and street , Squares areas, Pedestrian areas, Residential areas,Parks

Installing Hight: 3-5m

Lamps HID (HPS MH)/ LED bulb / CFL lamps, 30W-150W
 70W//150W HPS high pressure sodium, cap: E27/E26/E40/E39
 70W/150W/ MH metal halide, cap: E27/E26/E40/E39
 30W/40w/50W Led bulb, cap: E27/E26/E40/E39
 35W/45W/65W Compact fluorescent, cap: E27/E26

Input Voltage: 90-270VAC,50-60HZ

Material: FRP, fiber glass

Roof ,lens frame & reflector: Fiberglass-reinforced plastics,excellent mechanical strength and bear the causticity ,vacuum metalizing for the Reflector

Lens : Toughened flat glass

Color: Standard painting colors is black (BK) ,other colors dark grey(GY)(RAL7016),light grey(LG)(RAL7042) are available

Standards:

Isolation degree Class I, IP Rating IP65

Photometrics

Photometric curve

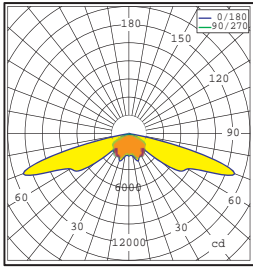

Lamp:150W HPS 15000Lm

TYPE III

Isolux curve

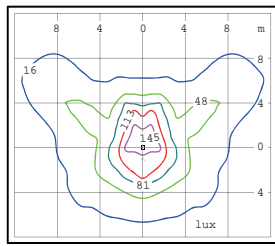

Mounting Height:4m

Photometric curve

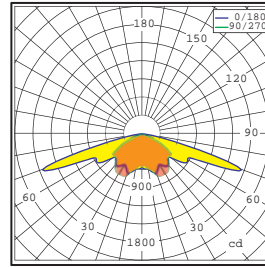

Lamp:70W HPS 6000Lm

TYPE III

Isolux curve

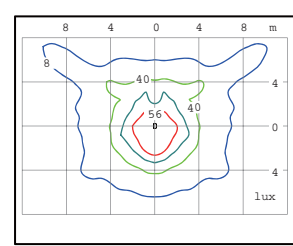

Mounting Height:4m

Ordering Guide

Luminaire No. - Pole No.

Order No.	HEIGHT mm	Luminaire Ctn. cm	Total Vol m ³	G.W./N.W. kg/ctn	QUANTITIES 20'/40'
HA305	230	60x50x25/1pcs	0.08	10/8	350/700
HA3051	4500	60x50x25/1pcs	0.24	47/45	120/250
HA3052	4500	60x50x25/1pcs	0.34	50/48	82/176

